



STOCKINGER
SAFETY FIRST CLASS

INSTALLATION INSTRUCTIONS

HELPFUL INFORMATION FOR THE INSTALLATION OF A STOCKINGER SAFE

1. RIGHT HEIGHT AND GOOD VISIBILITY
2. INSTALLATION ON FLOOR HEATING
3. REQUIRED SPACE TO OPEN DOOR
4. INTEGRATION OF A SAFE IN A WARDROBE
5. POWER SUPPLY (LIGHT)
6. ALARM SYSTEM
7. POWER SUPPLY FOR „STOCKTRONIC“ SECURITY LOCK
8. INCLUDED POWER-CONVERTER FOR THE LIGHT

STOCKINGER.COM
■ ■ ■ HANDCRAFTED IN GERMANY

1. RIGHT HEIGHT AND GOOD VISIBILITY

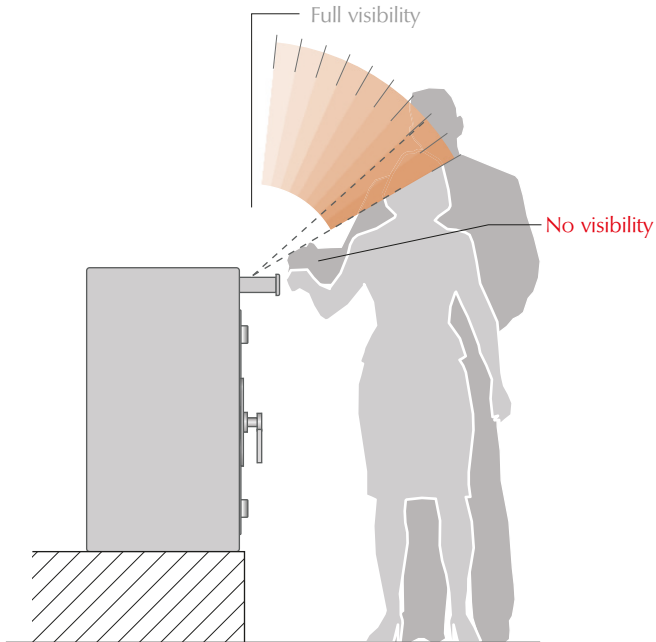

Please take care of the installation height.
Make sure you have full view of the control panel

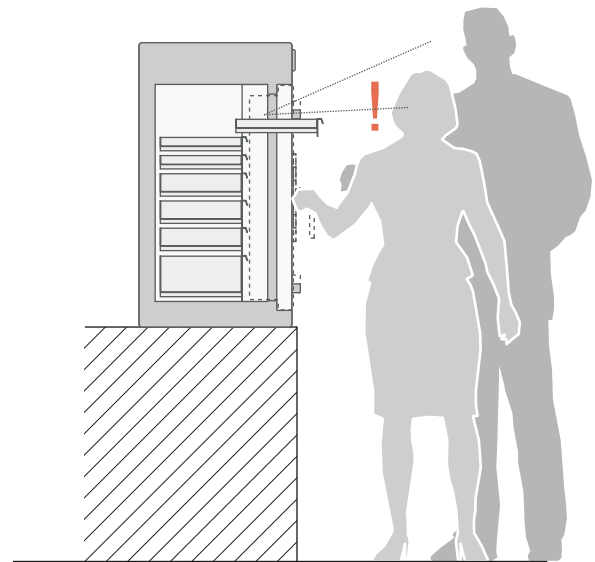

Make sure you have easy access to and full view of your drawers.

2. INSTALLATION ON FLOOR HEATING

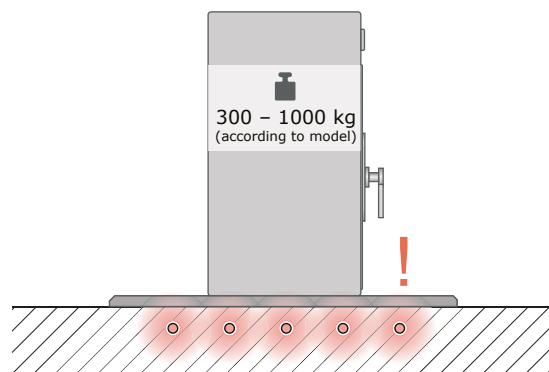

If you are using a Floor-Heating, in most cases a steel or wooden plate is needed to spread out the weight, not to damage the heating.
Please check with your architect first!

3. REQUIRED SPACE TO OPEN DOOR

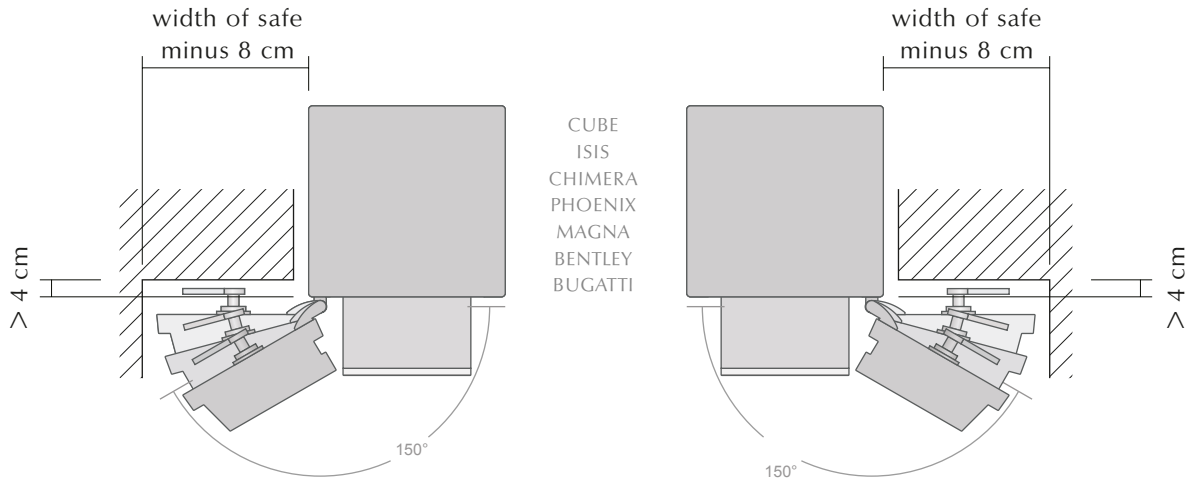

(EXAMPLE: ISIS = 52CM - 8CM = 44CM)

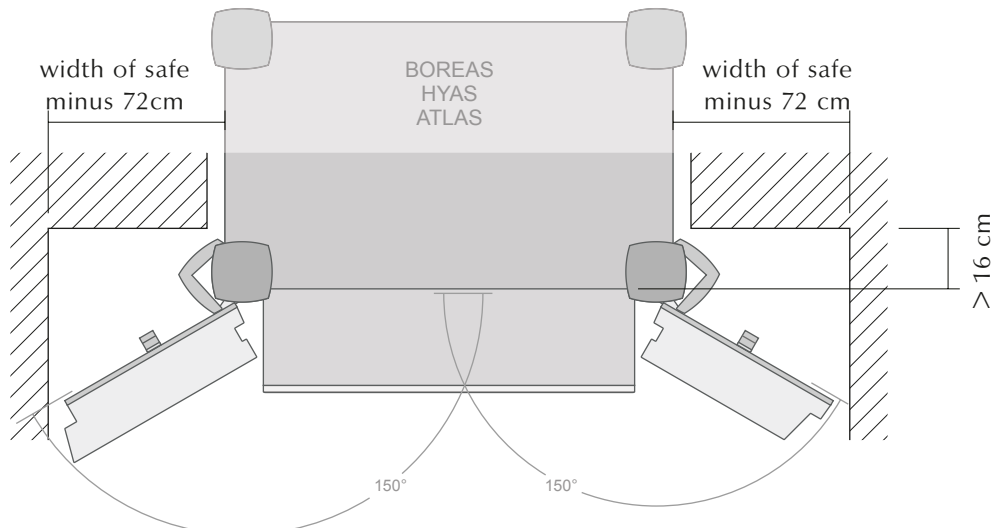
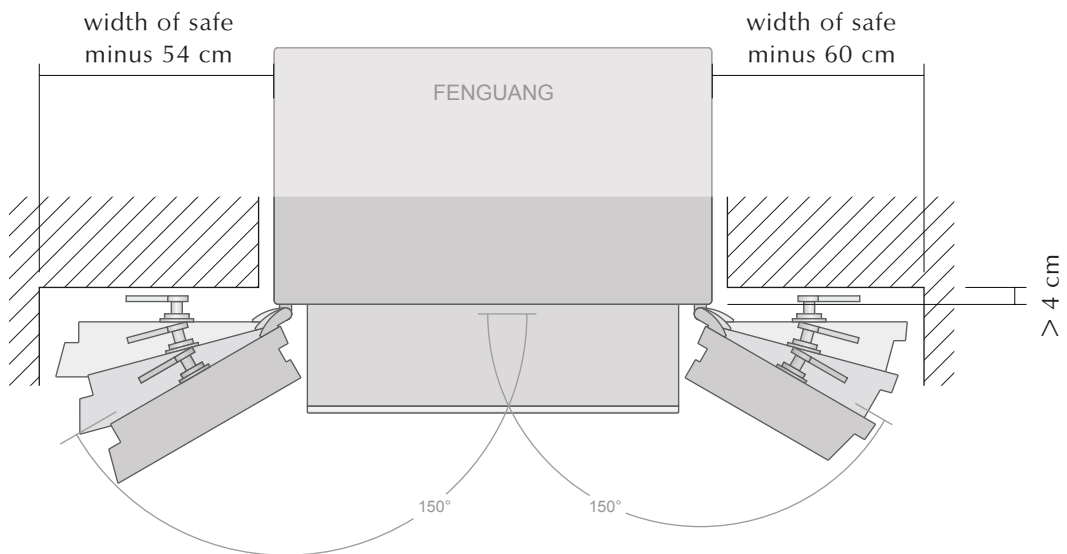

4. INTEGRATION OF A SAFE IN A WARDROBE

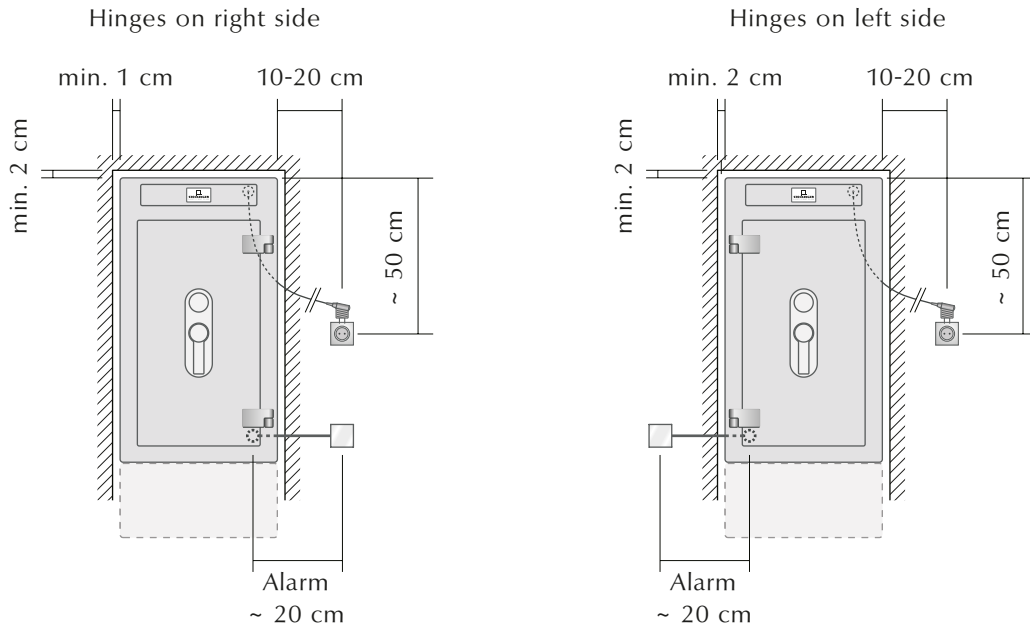

(Electricity is only needed for the internal light and not to operate the safe itself)

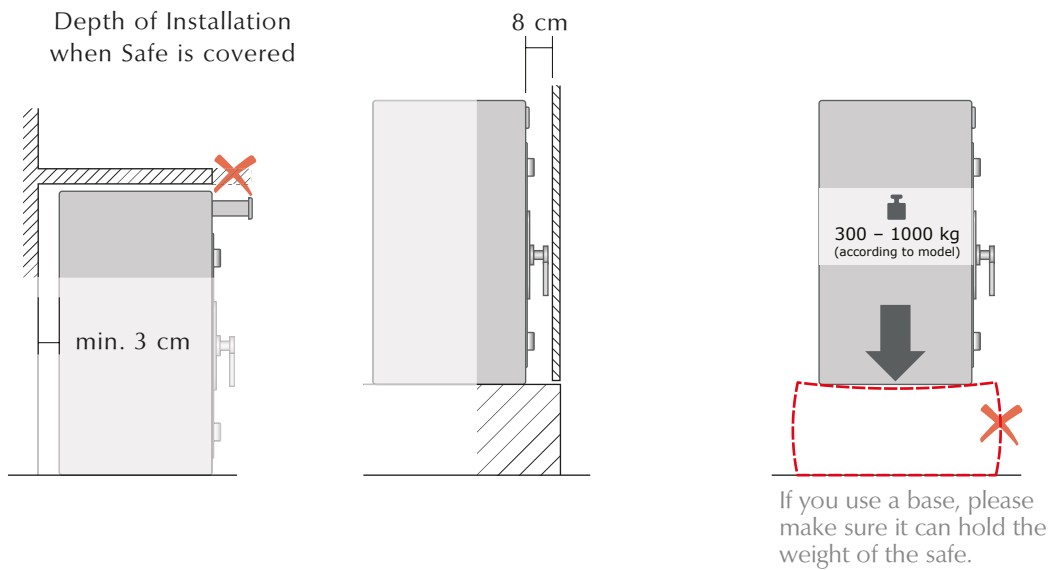

5. POWER SUPPLY (LIGHT)

Plug can be used both with 110 V and 220 V (EU and US)

CUBE – ISIS - CHIMERA 12 W
 BENTLEY - BUGATTI 12 W
 PHOENIX 28 W

Hinges on right side

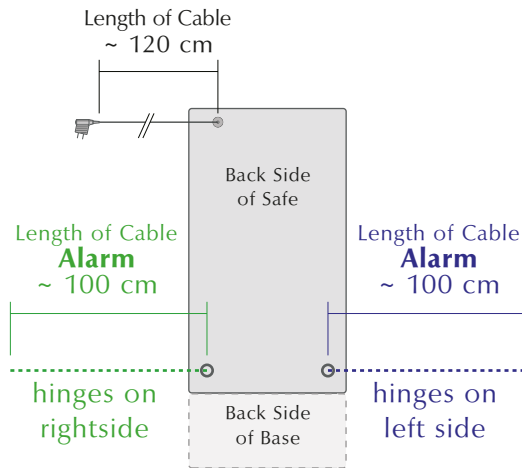
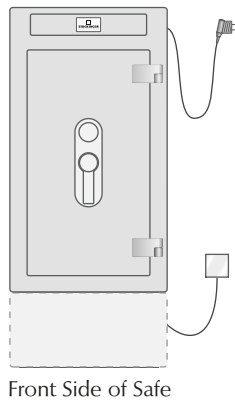

Hinges on left side

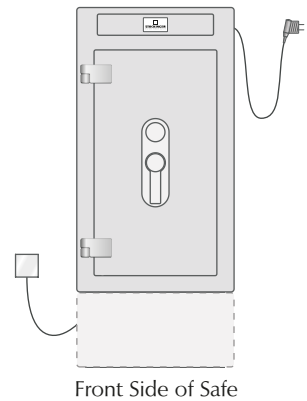

6. ALARM SYSTEM

Connection to Alarm-System

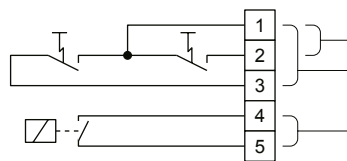

Lock 1 unlocked
 Lock 2 unlocked
 Duress alarm (hold-up)

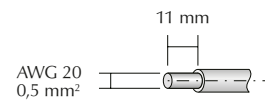

Cable Color
 yellow/green

Optional Functions (not available in Standard Options)

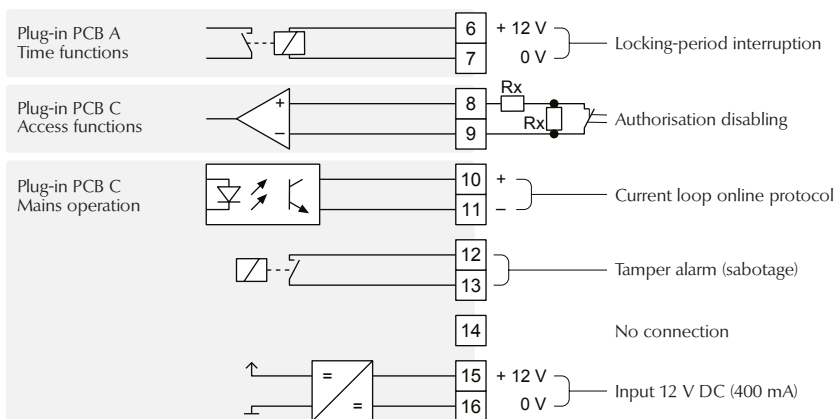

When „Mains Operation“ is used, the internal batteries of the „STOCKTRONIC“ must be replaced by an accumulator. This accumulator has to be replaced each 2 years.

7. POWER SUPPLY FOR „STOCKTRONIC“ SECURITY LOCK

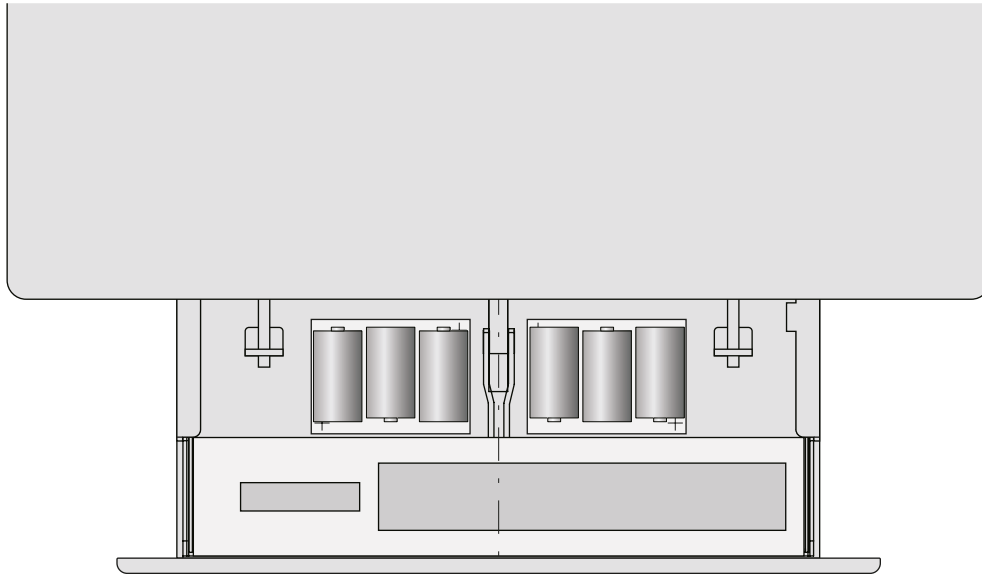

THE POWER SUPPLY FOR THE INTERNAL LIGHT IS INDEPENDENT OF THE POWER SUPPLY FOR THE SECURITY LOCK.

The „STOCKTRONIC“ Security System is powered by batteries:
6x 1,5 V Alkaline Batteries Size C (Baby).

To replace the batteries, please push the squared button at the „STOCKTRONIC“-drawer twice and hold it, so the drawer slides out

8. NECESSARY SPACE FOR THE POWER-CONVERTER

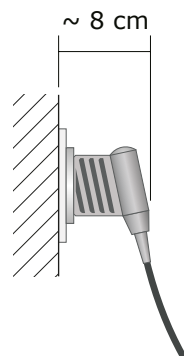

Plain Converter

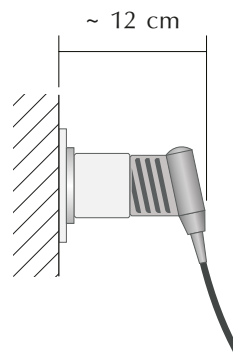

**Converter with Adapter
for the plug**

Minimum depth needed for the power-converter.