

STOCKINGER Safe CHIMERA III 12V

“Jet black - Silver - Dark grey”

Technical details and dimensions:

- Patented electronic locking system Stocktronic
- Integrated emergency alarm and anchoring device
- VDS security grade IV acc. to EU 1143/1
- HxWxD: 127x 67 x 55 cm / 50,0 x 26,4 x 21,6 inch
- Weight: ca. 750 kg / 1.653 lbs
- Volume: ca. 210 liter

Individual finish:

- Body and door in high-gloss Jet black lacquer
- Interior, facing and fittings lined in Stockinger Silver
- Free space (ingress height: 6 cm / inner height: 9 cm)
- One drawer (height: 20 cm), 12 watch winders
- Two drawers (height: 6 cm), lined in Dark grey suede
- Four drawers (height: 8 cm), lined in Dark grey suede
- One drawer (height: 10 cm), lined in Dark grey suede
- Seven trays for jewellery & watches in Dark grey suede
- Internal light system (white)

Price: 75.500 Euro (net, ex works)

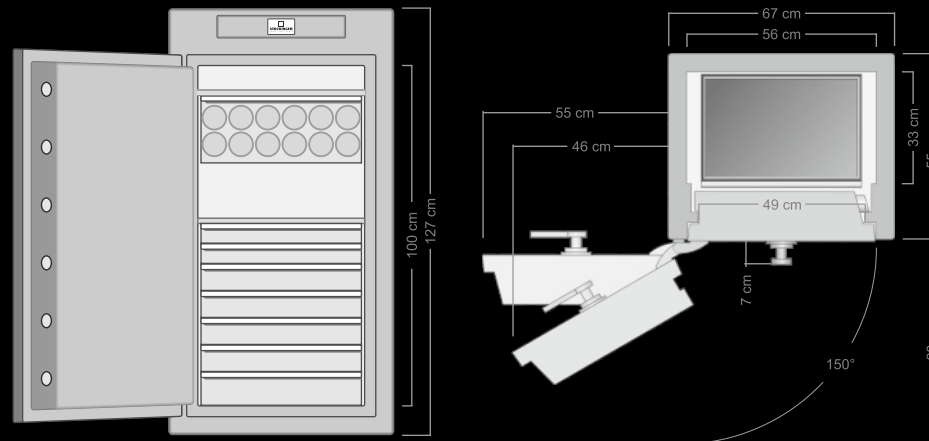

STOCKINGER MANUFATUR

Watch winder



drawer #1
tray #1

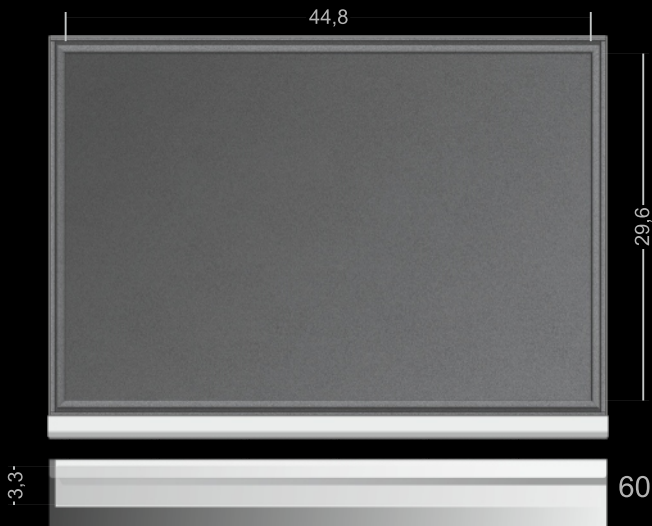

drawer #2
tray #2

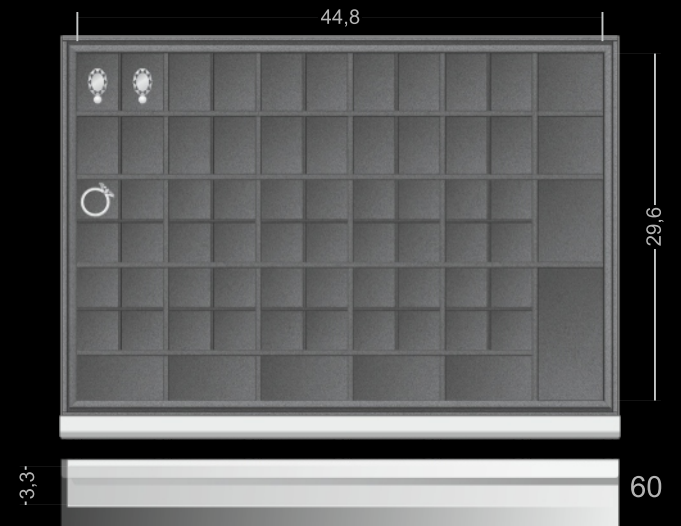

drawer #3
tray #3

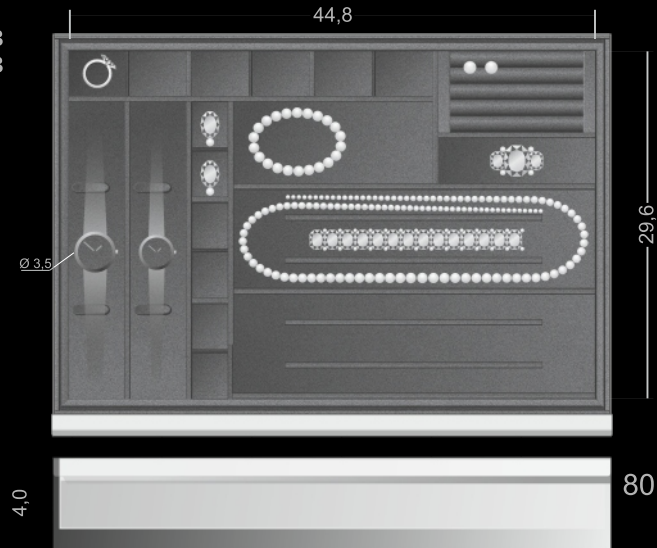

drawer #4
tray #4

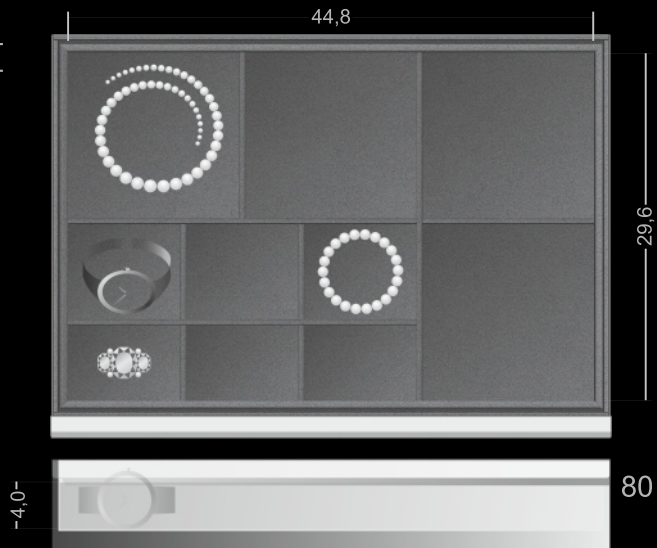

drawer #5
tray #5

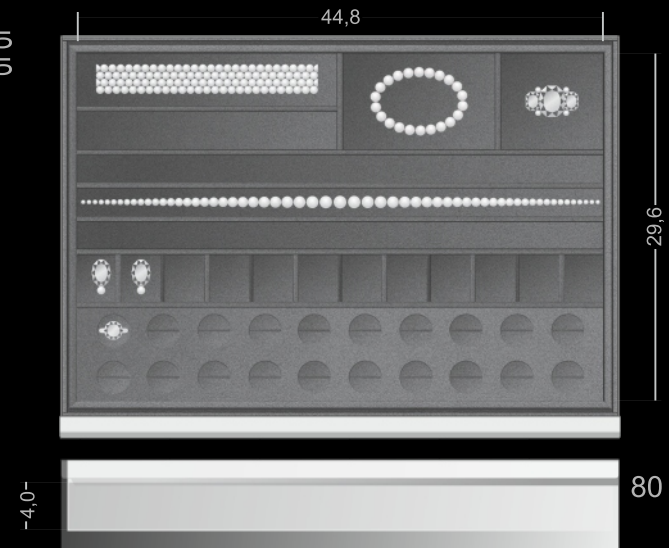

dimension = approx. centimeters
 1 cm = 0,39 in
 1 in = 2,54 cm

STOCKINGER MANUFAKTUR

EICHENSTRASSE 15 · 82061 NEURIED · GERMANY · TEL: +49 89-7590 5828 · FAX: +49 89-7590 5830 · INFO@STOCKINGER.COM
 WWW.STOCKINGER.COM

drawer #6
tray #6

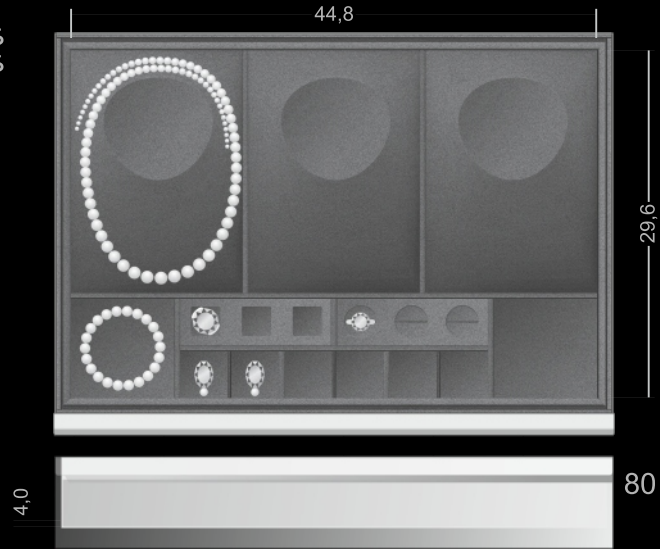

drawer #7
tray #7

